

**OFICIUL DE STAT PENTRU INVENȚII  
ȘI MĂRCI BUCUREȘTI ROMÂNIA**

**CERERI DE ÎNREGISTRARE A  
DESENELOR ȘI MODELELOR**

PUBLICATE ÎN

DATA DE 01/03/2023

**CLASA 11 - OBIECTE ORNAMENTALE**

(21) f 2023 0035; (22) 27/02/2023; (43) 01/03/2023;  
(71) **VASILE ALIN TEGLAS**, STR. MOINEȘTI NR. 14, BL. 205, SC. A, AP. 1, SECTOR 6, BUCUREȘTI, 061235, ROMANIA; (72) VASILE ALIN TEGLAS, STR. MOINEȘTI NR. 14, BL. 205, SC. A, AP. 1, SECTOR 6, BUCUREȘTI, 061235, ROMANIA; (54) **OBIECTE ORNAMENTALE**; (28) 20; (51) 11-01;

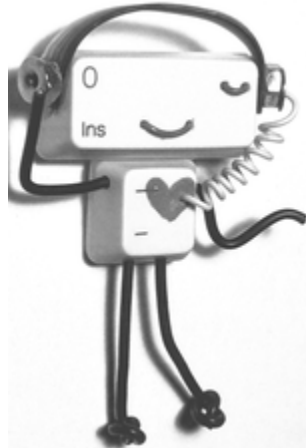

(21) f 2023 0035-1.1

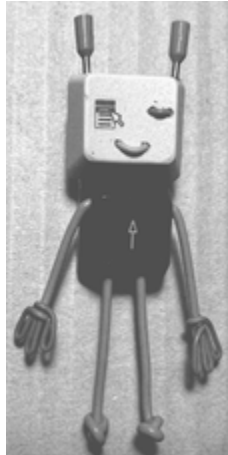

(21) f 2023 0035-2.1



(21) f 2023 0035-3.1

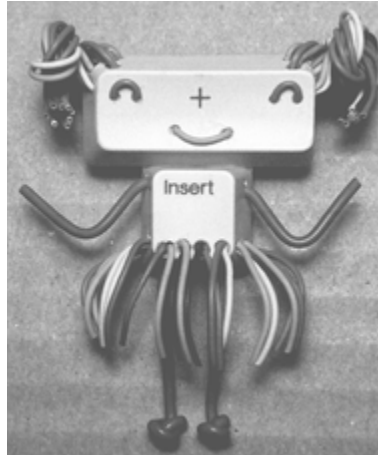

(21) f 2023 0035-4.1

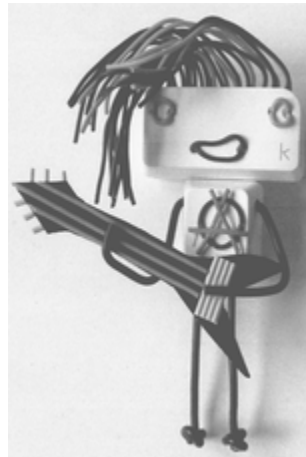

(21) f 2023 0035-5.1



(21) f 2023 0035-6.1



(21) f 2023 0035-7.1



(21) f 2023 0035-8.1

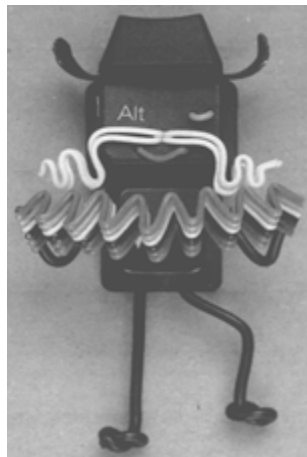

(21) f 2023 0035-9.1

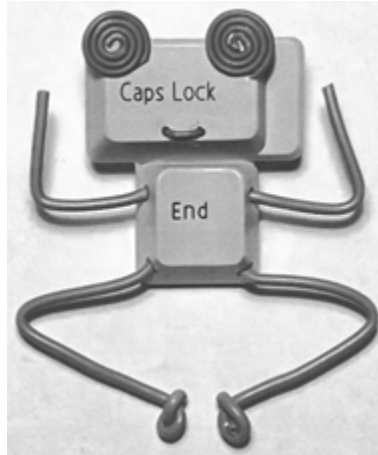

(21) f 2023 0035-10.1



(21) f 2023 0035-11.1



(21) f 2023 0035-12.1

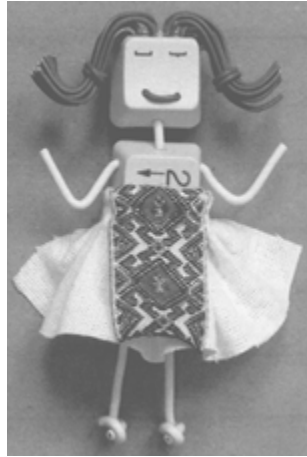

(21) f 2023 0035-13.1

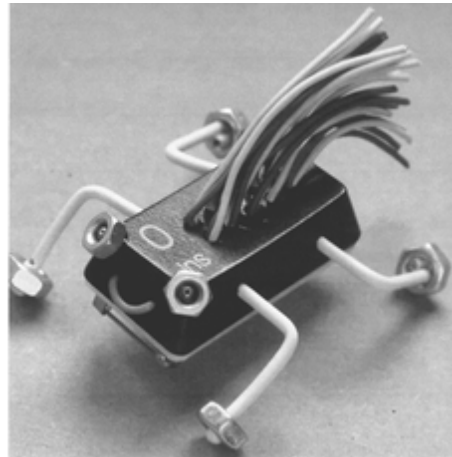

(21) f 2023 0035-14.1

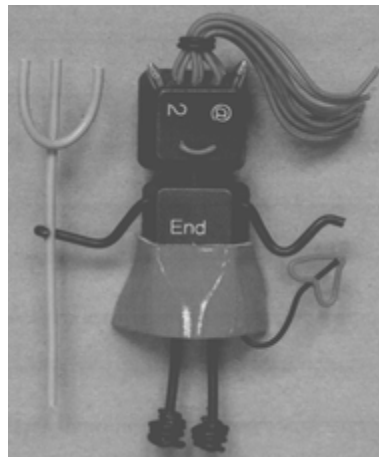

(21) f 2023 0035-15.1

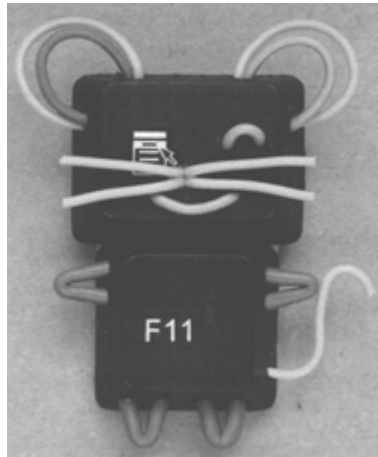

(21) f 2023 0035-16.1

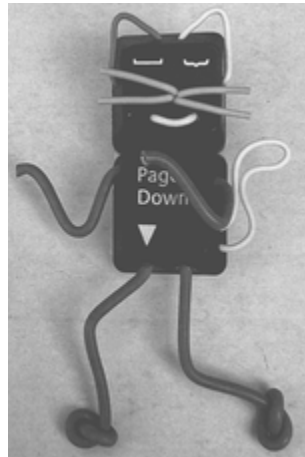

(21) f 2023 0035-17.1

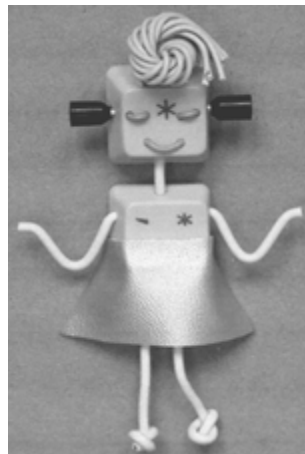

(21) f 2023 0035-18.1

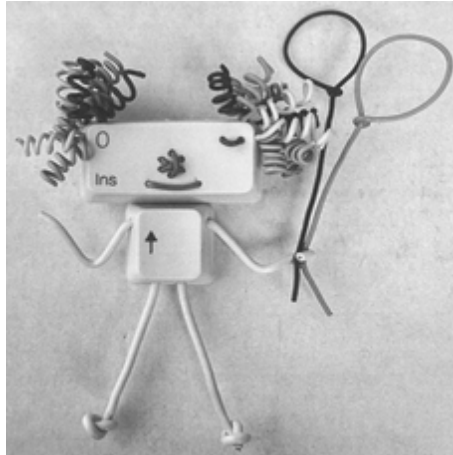

(21) f 2023 0035-19.1

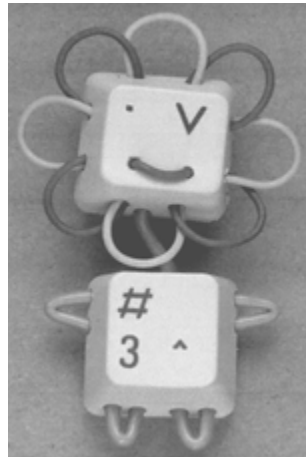

(21) f 2023 0035-20.1

---

**CLASA 15 - MAȘINI NECUPRINSE ÎN ALTE CLASE**

(21) f 2023 0012; (22) 17/01/2023; (43) 01/03/2023; (71) **SC LIM SERVOTECNITAL SRL**, STR. CAMELIEI NR. 3, TIMIȘOARA, 300714, TIMIȘ, ROMANIA; (72) MIREL MĂNIA, VIA MATTEOTTI 10A, SORESINA, 26015, ITALIA; ION ILIE MANIA, VIA VIALE SANTUARIO, 49, CASTELLEONE, ITALIA; (54) **PRESE PENTRU ULEI**; (28) 3; (51) 15-09;

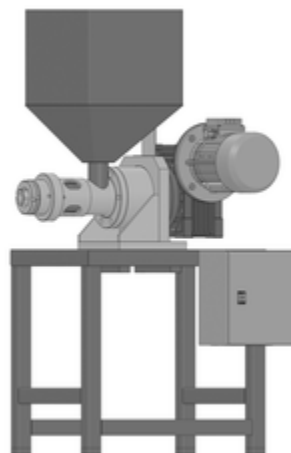

(21) f 2023 0012-1.1



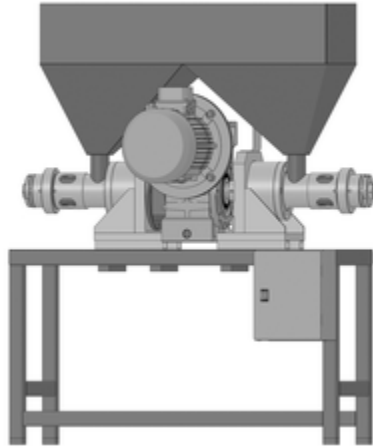

(21) f 2023 0012-2.1

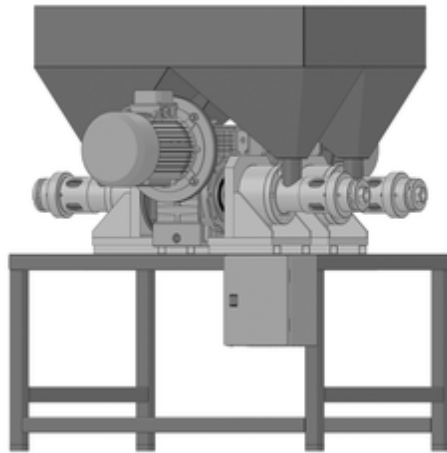

(21) f 2023 0012-3.1

---